

Han-Eco 10B Outd-HSM2-w. DL-M25-glanded

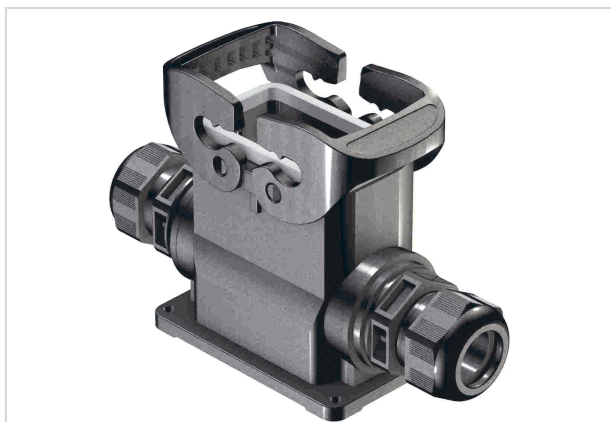

Image is for illustration purposes only. Please refer to product description.

Part number	19 43 310 0271
Specification	Han-Eco 10B Outd-HSM2-w. DL-M25-glanded
HARTING eCatalogue	https://b2b.harting.com/19433100271

Identification

Category	Hoods/Housings
Series of hoods/housings	Han-Eco® B
Type of hood/housing	Surface mounted housing
Description of hood/housing	With integrated cable gland

Version

Size	10 B
Version	Side entry
Cable entry	2x M25
Locking type	Double locking lever

Technical characteristics

Limiting temperature	-40 ... +125 °C
Note on the limiting temperature	For use as a connector according to IEC 61984.
Number of relockings	≥500
Degree of protection acc. to IEC 60529	IP66
Clamping range	9 ... 17 mm

Material properties

Material (hood/housing)	Polyamide (PA) Fibre-glass reinforced
Colour (hood/housing)	RAL 9005 (jet black)
Material (seal)	FPM



Pushing Performance
Since 1945

Material properties

Colour (seal)	RAL 7001 (silver-grey)
Material (locking)	Polyamide (PA) Fibre-glass reinforced
Colour (locking)	RAL 9005 (jet black)
Material flammability class acc. to UL 94	V-0
Material flammability class acc. to UL 94 (locking levers)	V-0
RoHS	compliant with exemption
RoHS exemptions	6(c): Copper alloy containing up to 4 % lead by weight
ELV status	compliant with exemption
China RoHS	50
REACH Annex XVII substances	Not contained
REACH ANNEX XIV substances	Not contained
REACH SVHC substances	Yes
REACH SVHC substances	Lead
California Proposition 65 substances	Yes
California Proposition 65 substances	Lead
Fire protection on railway vehicles	EN 45545-2 (2020-08)
Requirement set with Hazard Levels	R22 (HL 1-3) R23 (HL 1-3)

Specifications and approvals

Specifications	IEC 61984 EN 45545-2 Fire protection on railway vehicles
CE	Yes

Commercial data

Packaging size	1
Country of origin	Germany
European customs tariff number	85389099
GTIN	5713140177895
eCl@ss	27440202 Shell for industrial connectors